

USB 3.2 RFI System-Level Test Procedure

Rev1.3
May 26, 2021

Test Applicability

This test is only applicable to systems with Type C Connector and support data speeds 5Gbps and above

- USB 3.2 Hosts End Product (This includes embedded hosts)
- USB 3.2 Hubs End Product
- DRD

Equipment List

No	Equipment Name	Vendor	P/N
1	Signals/Spectrum Analyzer	Anritsu/Keysight/R&S	MS2830A /N9000B/FPL1007
2	RFI System Level Test Fixture	Luxshare-ICT	MEU-58P1F
3	RF Cable 1m	Junkosha	MWX121-01000DMSDMS
4	RF Cable 0.5m	Junkosha	MWX121-00500DMSDMS
5	Shielding Box	Lab105	SHD6001A
6	AC Power Filter Module	SpeedTech	L08PT02-00001
7	Banana Plug Filter Module (DC Power Filter)	SpeedTech	L08PT04-00001
8	USB Type C Filter Module	SpeedTech	L08PT03-00001
9	USB Type A Filter Module	SpeedTech	L08PT05-00001
10	Test Table	Luxshare-ICT	MEU-39P1F
11	5 in-lbs. torque wrench	Luxshare-ICT	MEW-40A11

Please contact Od.Liao@luxshare-ict.com for Luxshare and Lab105 parts.

Signal/Spectrum Analyzer Test Configuration

It is highly recommended to have the built-in preamplifier function option for the signal analyzer.

List of approved Signal/Spectrum Analyzers:

Anritsu MS2830A

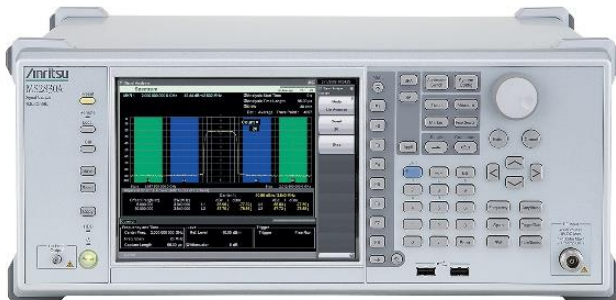

Keysight N9000B



Rohde & Schwarz FPL1007



Setting	ANRITSU	KEYSIGHT	ROHDE & SCHWARZ
Frequency Range 500MHz to 6GHz	Frequency> Start: 500MHz Stop: 6GHz	Frequency> Start: 500MHz Stop: 6GHz	Frequency> Start: 500MHz Stop: 6GHz
RBW: 100KHz, VBW: 100KHz	BW> RBW: 100KHz VBW: 100KHz	BW> RBW: 100KHz VBW: 100KHz	A/D Bandwidth> RBW: 100KHz VBW: 100KHz
Average Detector	Average type> Trace> Detector> Detector: RMS	Trace> Detector> Detector: Average (log/RMS/V)	Analysis> Trace#> Detector: RMS
Average times: 100	Storage count: 100	Avg. Hold number: 100	Average times: 100
Attenuation	AMPTD> Attenuation: 0dB	AMPTD> Attenuation: 0dB	Amplitude> Att: 0dB
Trace type	Trace> Storage mode: Average	Trace> Trace type: Average	Analysis> Trace: Average
Trigger source	Trig: Free run (default)	Trig: Free run (default)	Trig: Free run (default)
Pre-AMP	AMPTD> Signal path> Internal Preamp: Full range (on)	AMPTD> Signal path> Internal Preamp: Full range (on)	Amplitude> Preamp: on
Test environment	Shielding box	Shielding box	Shielding box

USB RFI System Level Test Fixture



RF Cable Requirement

1. RF Cable: Frequency higher than 6GHz

Shielding Box Requirement

The shielding box isolation level must be higher than 80dB for full test frequency range (500MHz to 6GHz) and inside dimensions must be large enough for a desktop computer. Below is recommend shielding box dimension and real item picture:

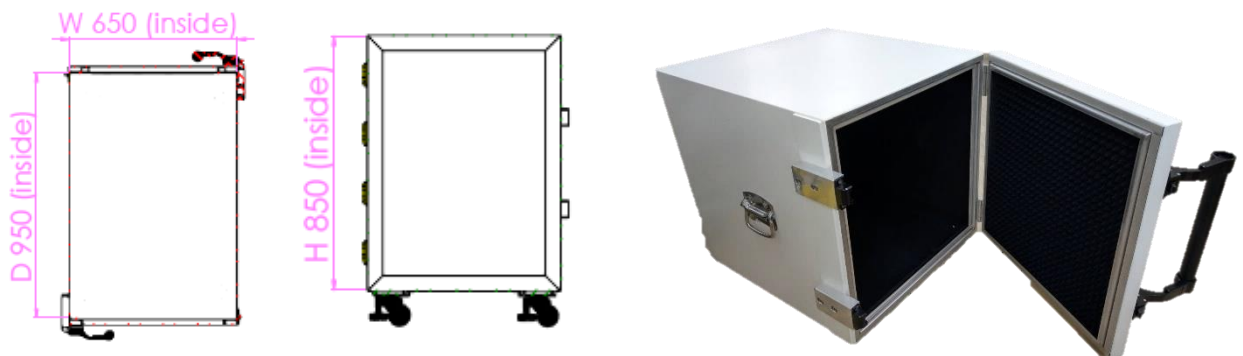

Filter Modules

1. AC power filter

AC power filter is support 100V~220V, 50Hz to 60Hz

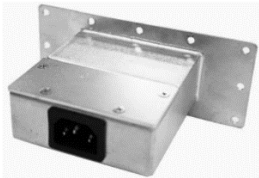

2. Banana plug filter (DC power filter)



3. USB Type C filter (USB signals)

Supports USB 3.2 Gen1/Gen2

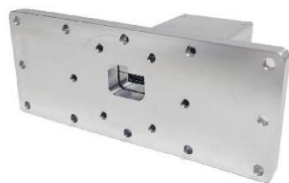

4. USB Standard filter (USB signals)

Supports USB 3.2 Gen1/Gen2



Test Setup

1. Mobile Devices (Laptops/Notebooks/Smartphone)

Note: DUT must be in airplane mode during testing

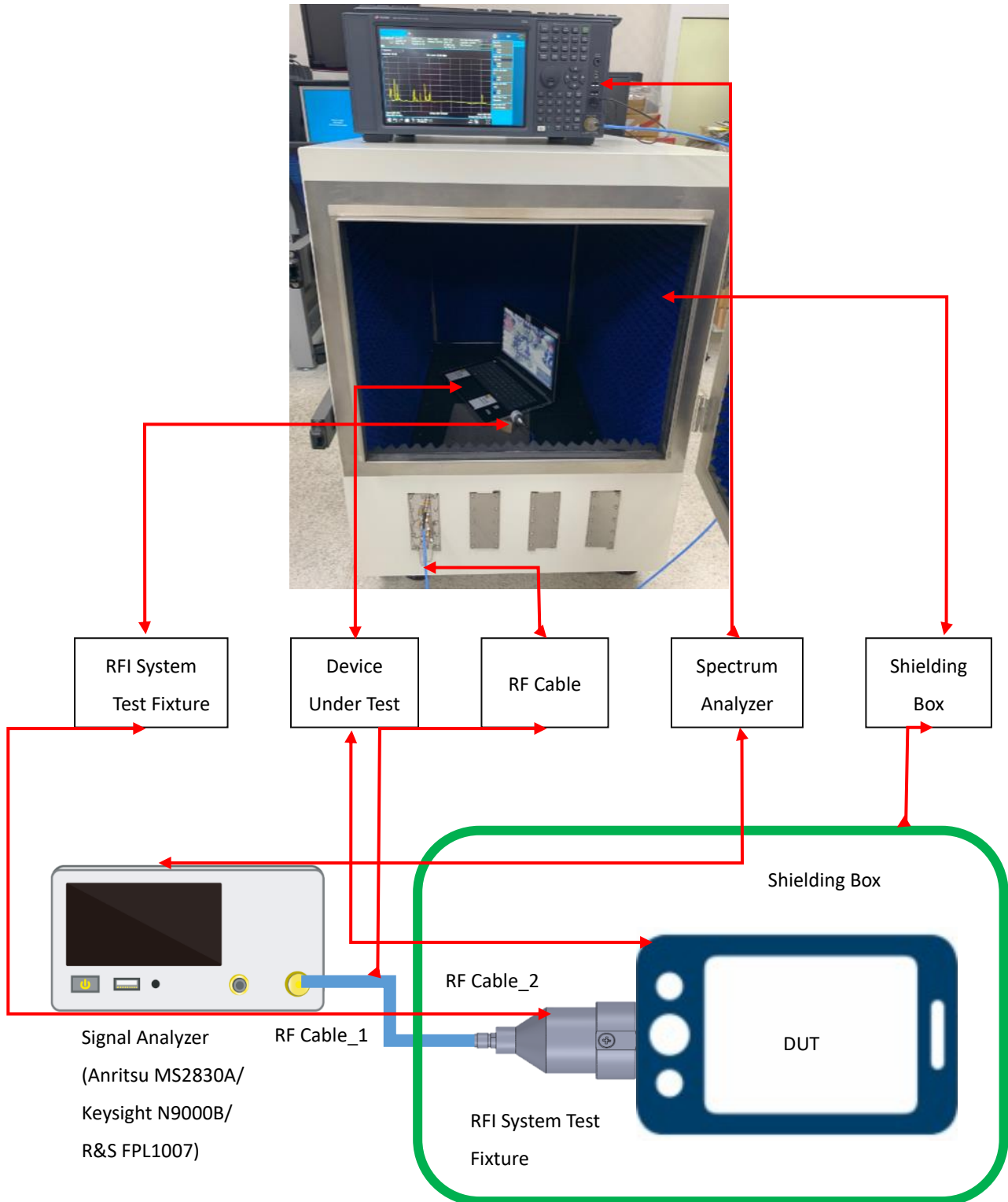

2. DUT with AC power source

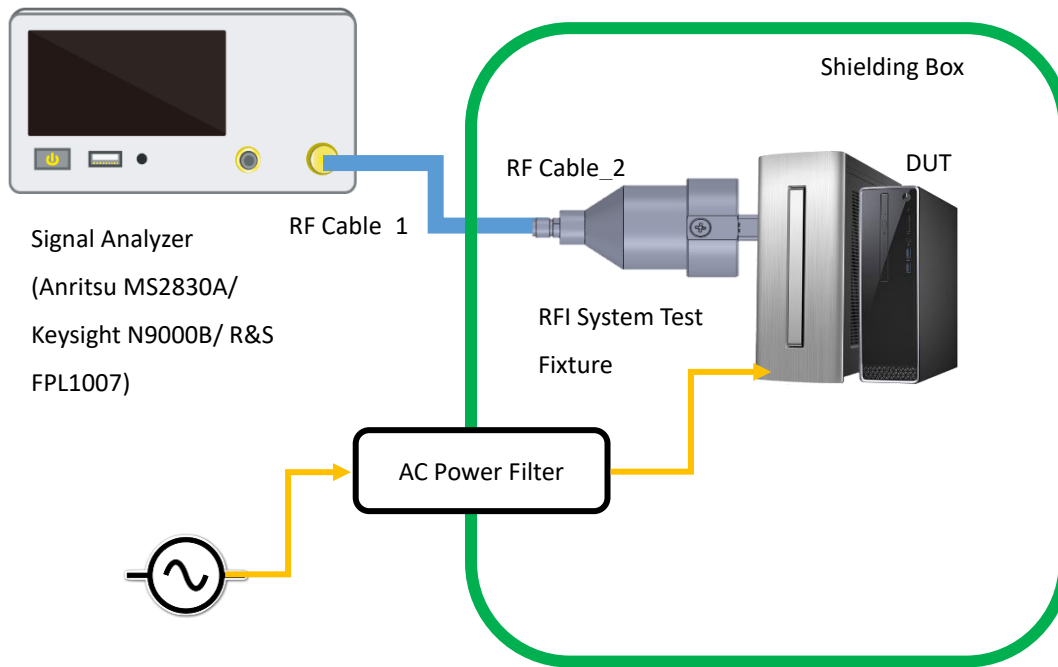

3. Dock/Hub type with AC power source

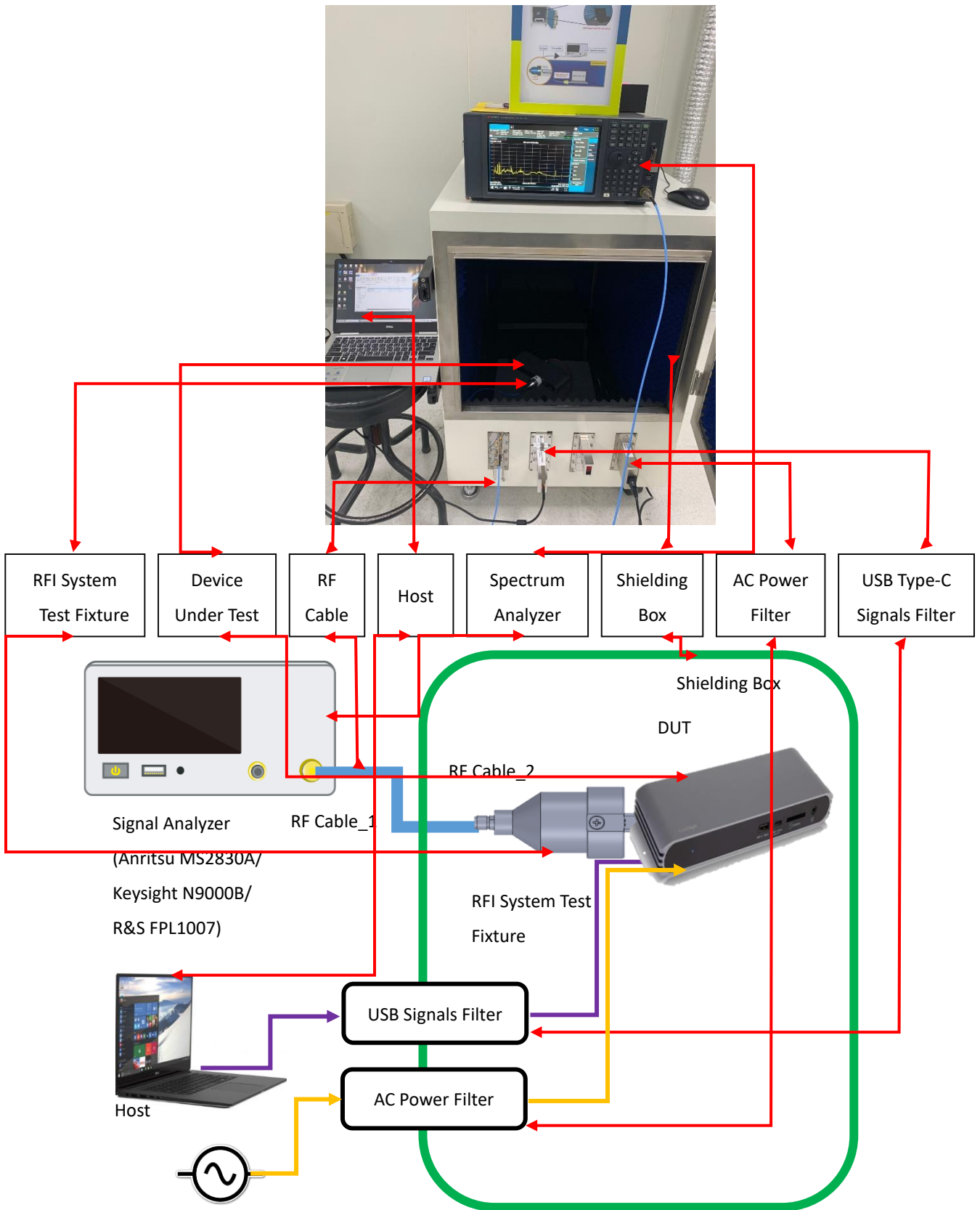

4. Dock/Hubs

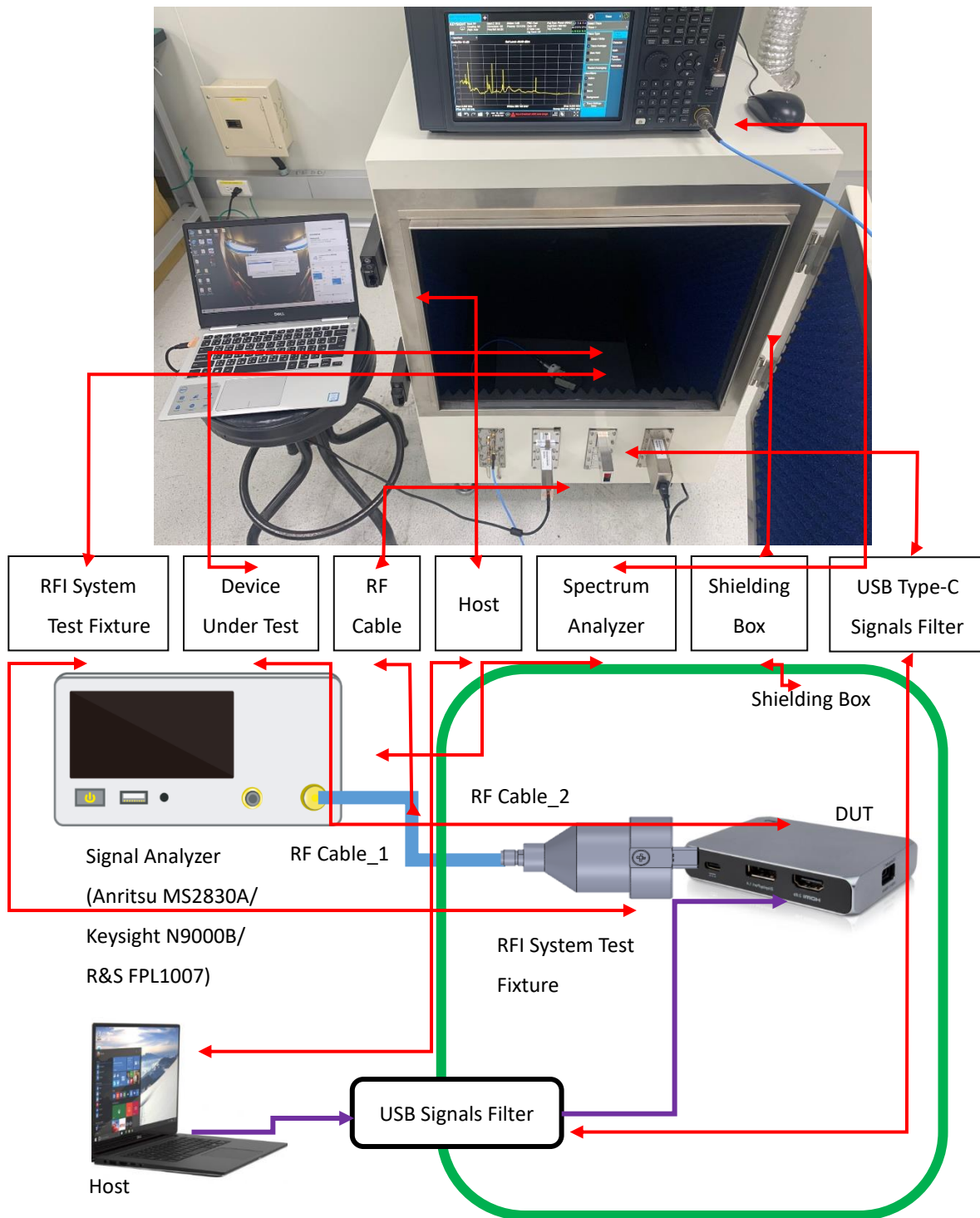

Test Procedure (Windows OS based systems)

1. Please make sure you have performed the [Test Setup](#) and read any notes contained within for DUT test setup before proceeding.
2. Find out the port assignments for the exposed USB Type C ports of the DUT. This can be done by asking the customer about the port assignments or by utilizing USBView and plugging in a USB 3.2 device/hub with a Type C connector. Take note of what port number it is enumerated under this is important information for using XHSETT tool for generating CPO and recording compliance test results.

USBView (<https://docs.microsoft.com/en-us/windows-hardware/drivers/debugger/usbview>)

3. Configure the Signal Analyzer by referring to the parameters in (Signal Analyzer Test Configuration Section) then check the noise floor of the analyzer by leaving the RF input of the analyzer open. Noise floor should be less than or equal to -105dBm. Refer to the test setup shown (Test Setup Section) to setup the connection and make sure to tighten the connections using a 5 in-lbs. torque wrench where applicable.
4. Set limit lines in the Analyzer for the compliance test for pass/fail, 500MHz to 4GHz >- 100 dBm, 5GHz to 6GHz >-102 dBm

An alternative way is to export the measured signal from the analyzer as .csv and use a spreadsheet program to convert the values to a table. Please refer to the table below.

Ex.

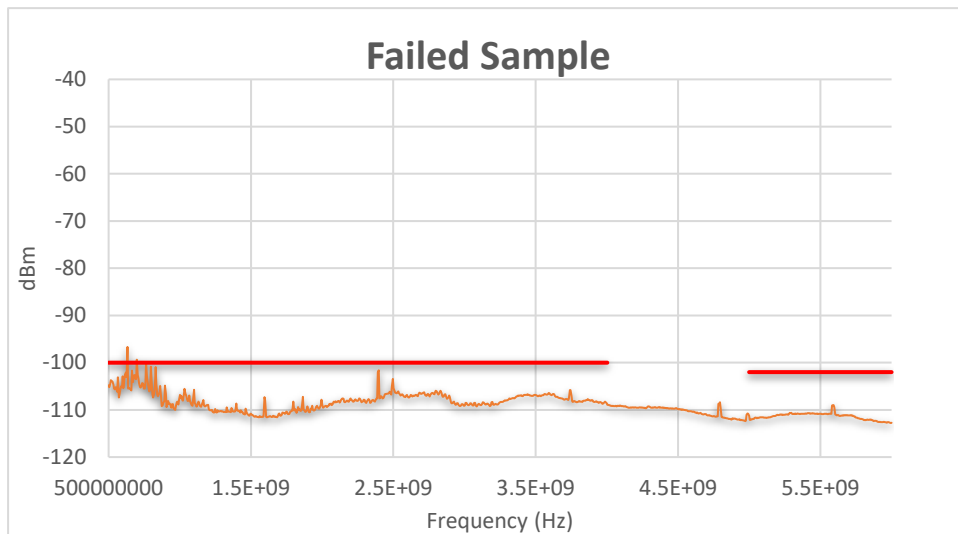

5. Launch XHSETT. The tool can be downloaded from:
[https://usb.org/document-library/xhsett-x64; for 64-bit OS](https://usb.org/document-library/xhsett-x64;for 64-bit OS)
[https://usb.org/document-library/xhsett-x32; for 32-bit OS](https://usb.org/document-library/xhsett-x32;for 32-bit OS)
6. Select Host/Hub DSF Ports under the SuperSpeed section then select host controller for use in testing.

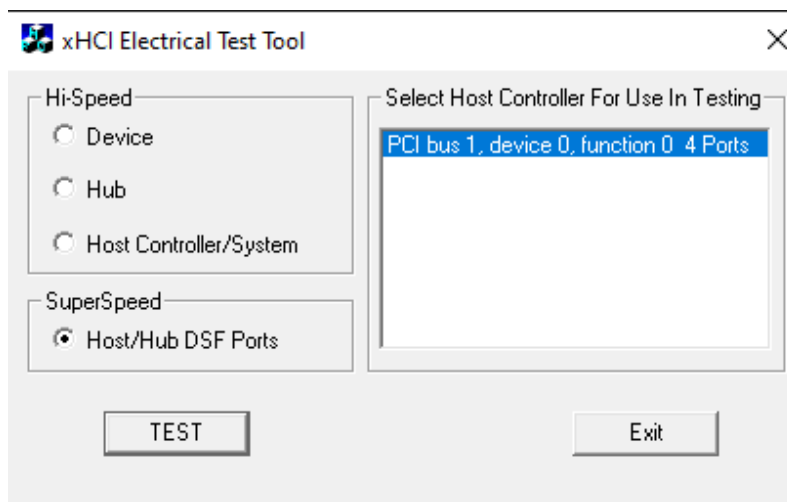

7. Enumerate Bus and Select Host.

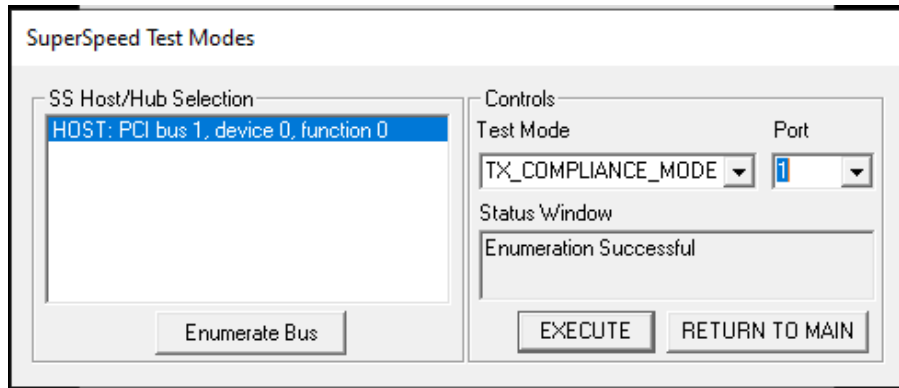

8. In the Controls section, select TX_COMPLIANCE_MODE from the drop-down menu under Test Mode. Choose the port number for the PUT then click execute and make sure status window shows "Operation Successful".

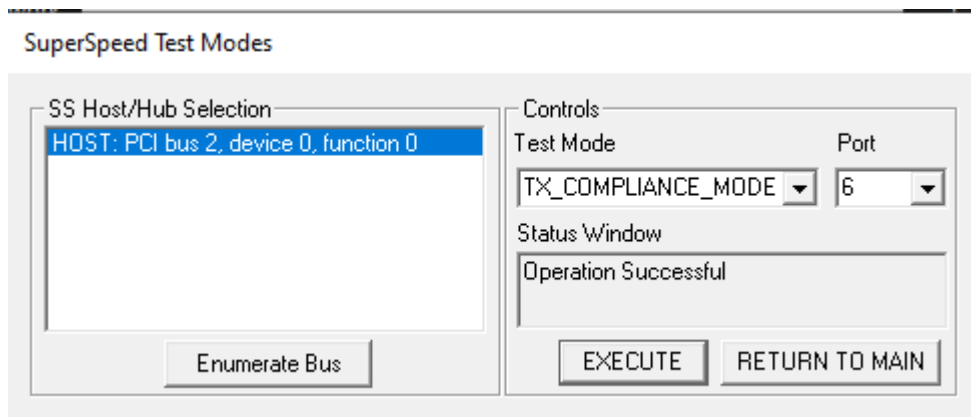

9. Plug in RFI system level test fixture to PUT and make sure the platform for testing is stable (i.e., no wobbling, no vibrations and etc.). Close shielding box then Start sweep (make sure it counts 100 average and save the waveform when done, test the other orientation and proceed to the next port (if DUT has more than 1 Type C port)).

Test Procedure (non-Windows based Operating Systems)

1. Find out the port assignments for the exposed USB Type C ports of the DUT. The most convenient way is by asking the customer about the port assignments or please use whatever tool is available.
2. Configure the Signal Analyzer by referring to the parameters in (Signal Analyzer Test Configuration Section) then check the noise floor of the analyzer by leaving the RF input of the analyzer open. Noise floor should be less than or equal to -105dBm. Refer to the test setup shown (Test Setup Section) to setup the connection and make sure to tighten the connections using a 5 in-lbs. torque wrench where applicable.
3. Set limit lines in the Analyzer for the compliance test for pass/fail, 500MHz to 4GHz >- 100 dBm, 5GHz to 6GHz >-102 dBm

An alternative way is to export the measured signal from the analyzer as .csv and use a spreadsheet program to convert the values to a table. Please refer to the table below.

Ex.

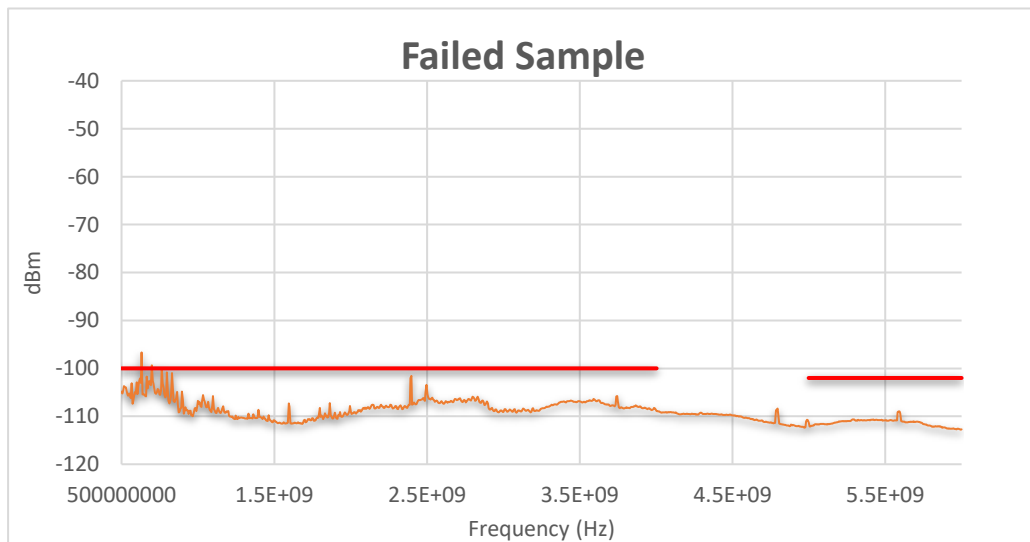

4. Use any method/tool to make sure DUT goes and stays into compliance mode generating CPO

5. Plug in RFI system level test fixture to PUT and make sure the platform for testing is stable (i.e., no wobbling, no vibrations and etc.). Close shielding box then Start sweep (make sure it counts 100 average and save the waveform when done, test the other orientation and proceed to the next port (if DUT has more than 1 Type C port).

Test Pass/Fail Criteria

PUT generated CP signal shall have noise emissions below the specified noise levels within the specified range.

Condition:

1. PUT shall have noise levels less than -100 dBm in the 500 MHz to 4 GHz range
2. PUT shall have noise levels less than -102 dBm in the 5 GHz to 6 GHz range
3. PUT shall meet conditions 1 and 2 in both orientations (normal and flipped)

Revision History

Revision	Date	Description	Author
1.0	8/21/2020	Initial Release	Joshua Talactac
1.1	11/19/2020	Improved Clarity, Fixed Formatting and added sections "Optional Tools and Accessories", Pass/Fail Criteria and "Test Procedure for non-Windows based Operating Systems" and updated equipment P/N	Joshua Talactac
1.2	05/03/2021	Added R&S as to the list of approved signal analyzers with settings and config. Added 4 filter modules. Added Test Setups for other DUT Types	Joshua Talactac
1.3	05/26/2021	Clarified pass/fail criteria: added third condition. Added note to mobile devices test setup: must be in airplane mode during test.	Joshua Talactac

For questions, please feel free to contact techadmin@usb.org for more information.